

Powered by



# HRL 12150W ▶ 12V 150W

HRL 12150W is specially designed for high efficient discharge application. Its characteristics are high energy density, small footprint and high discharge efficiency. It can be used for more than 260 cycles at 100% discharge in cycle service, up to 10 years in standby service.



## Specification

Cells per unit	6
Voltage per unit	12
Capacity	150W @ 15min-rate to 1.67V per cell @25 °C(77°F)
Weight	Approx. 11.75 kg(25.9 lbs)
Maximum Discharge Current	225A(5sec)
Internal Resistance	Approx. 7 mΩ
Operating Temperature Range	Discharge: -15°C~50°C ( 5°F~122°F) Charge: -15 °C~40°C ( 5°F~104°F) Storage: -15°C~40°C ( 5°F~104°F)
Nominal Operating Temperature Range	25°C±3°C (77°F±5°F)
Float Charging Voltage	13.5 to 13.8 VDC/unit Average at 25°C (77°F)
Recommended Maximum Charging Current Limit	15A
Equalization and Cycle Service	14.4 to 15.0 VDC/unit Average at 25°C (77°F)
Self Discharge	CSB Batteries can be stored for more than 6 months at 25°C (77°F). Please charge batteries before using. For higher temperatures the time interval will be shorter.
Terminal	I2-Thread lead alloy recessed terminal to accept M6 bolt
Container Material	ABS(UL 94-HB) & Flammability resistance of (UL 94-V0) can be available upon request.



CSB-manufactured **VRLA** (Absorbent Glass Mat type) batteries are UL-recognized components under UL1989.

CSB is also certified by ISO 9001 and ISO 14001.

Dimensions :	Overall Height (H)	Container height (h)	Length (L)	Width (W)
Unit: mm (inch)	172.0±2.0 (6.77±0.08)	172.0±2.0 (6.77±0.08)	195.6±2.0 (7.70±0.08)	130.0±1.5 (5.12±0.06)

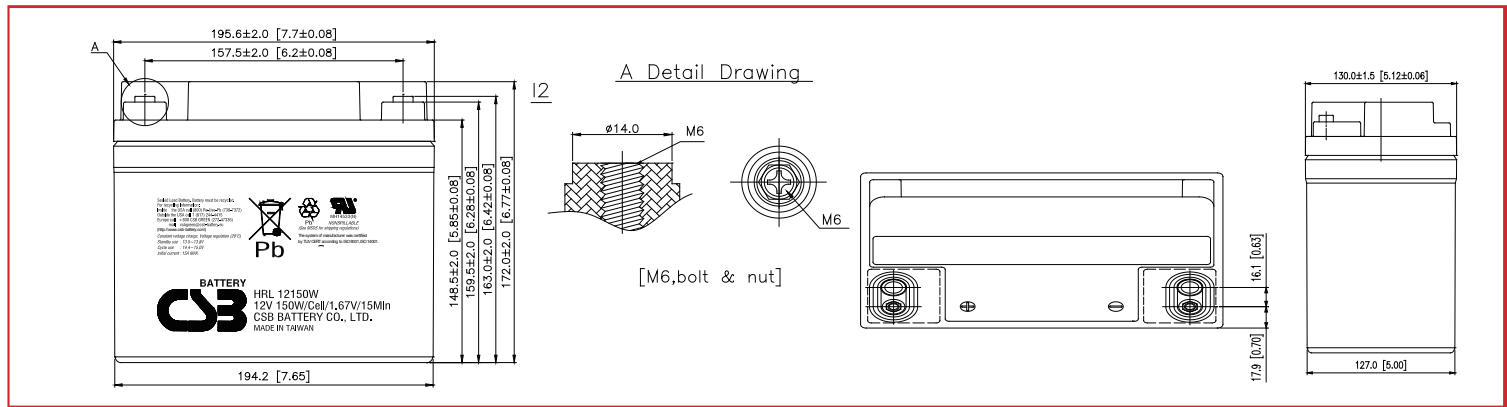

## Constant Current Discharge Characteristics Unit:A (25°C, 77°F)

F.V/Time	5MIN	7.5MIN	10MIN	15MIN	20MIN	30MIN	40MIN	50MIN	60MIN	90MIN
1.60V	169	138	116	86.7	69.6	50.4	40.0	33.5	28.9	20.8
1.67V	152	127	107	82.2	66.3	48.4	38.7	32.5	28.6	20.5
1.70V	144	122	103	80.0	64.7	47.5	38.0	32.1	28.4	20.4
1.75V	132	112	96.8	76.0	62.0	45.7	36.8	30.9	27.8	20.0
1.80V	119	104	90.0	71.1	58.4	43.8	35.1	29.8	26.8	19.5
1.85V	107	94.1	82.8	67.0	55.1	41.7	33.6	28.6	25.0	18.6

## Constant Power Discharge Characteristics Unit:W (25°C, 77°F)

F.V/Time	5MIN	7.5MIN	10MIN	15MIN	20MIN	30MIN	40MIN	50MIN	60MIN	90MIN
1.60V	1,794	1,479	1,263	968	788	577	463	387	335	244
1.67V	1,624	1,370	1,182	935	753	559	451	386	334	239
1.70V	1,549	1,322	1,143	916	737	548	442	382	332	236
1.75V	1,422	1,234	1,075	877	704	530	428	374	325	231
1.80V	1,302	1,143	1,006	825	675	507	410	361	314	226
1.85V	1,188	1,057	943	773	639	486	396	337	296	222

Ratings presented herein are subject to revision without notice. Please refer to [www.csb-battery.com](http://www.csb-battery.com) to confirm the latest version.

### Trickle (or Float) Service Life

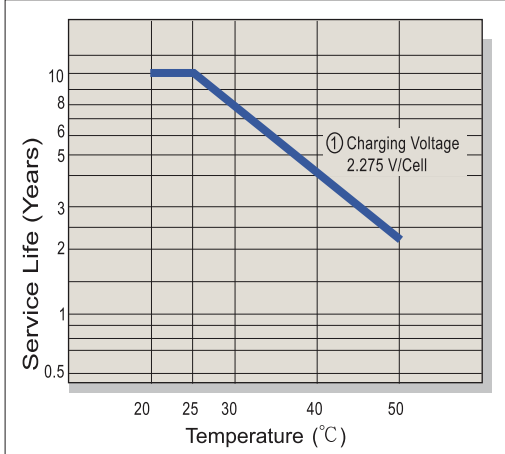

### Capacity Retention Characteristic

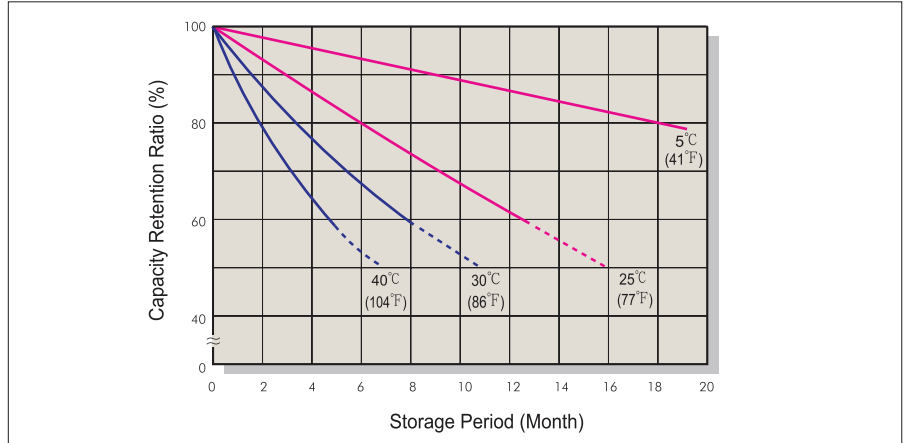

### Battery Voltage and Charge Time for Standby Use

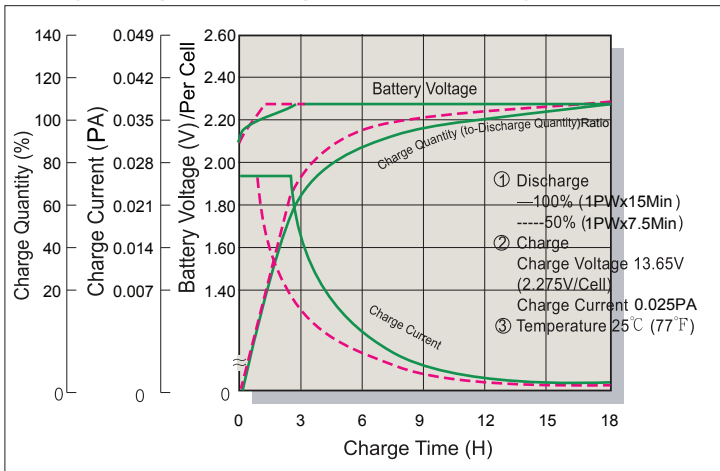

### Cycle Service Life

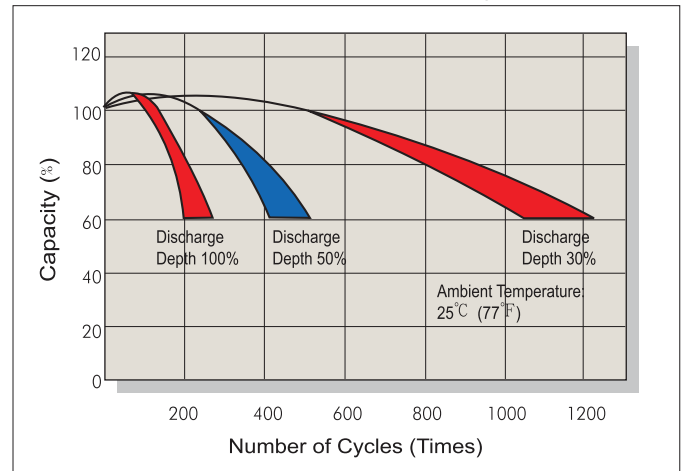

### Battery Voltage and Charge Time for Cycle Use

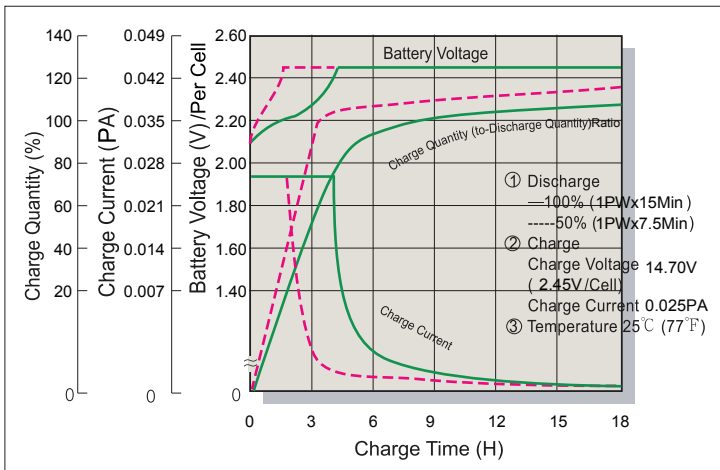

### Terminal Voltage (V) and Discharge Time

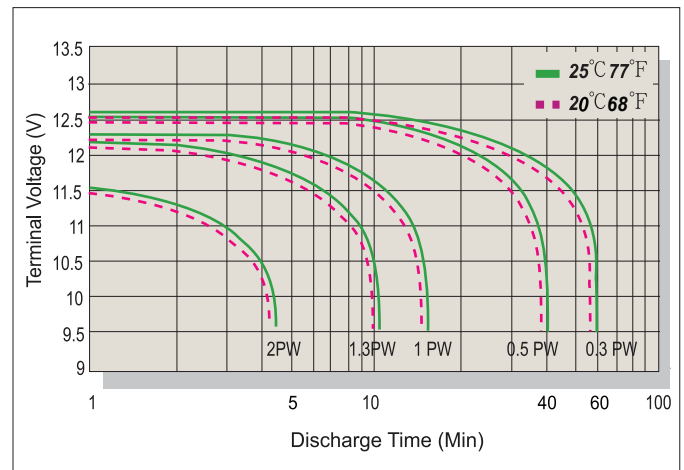

### Charging Procedures

Application	Charge Voltage(V/Cell)			Max.Charge Current
	Temperature	Set Point	Allowable Range	
Cycle Use	25°C(77°F)	2.45	2.40~2.50	0.1PA
Standby	25°C(77°F)	2.275	2.25~2.30	

### Discharge Current VS. Discharge Voltage

Final Discharge Voltage V/Cell	1.75	1.70	1.60	1.30
Discharge Power(W)	0.1P>(W)	0.1P≤(W)<0.25P	0.25P≤(W)<1.0P	(W)≥1.0P

Sales Office URL: [WWW.CSB-BATTERY.COM](http://WWW.CSB-BATTERY.COM)

#### GLOBAL HQ CSB BATTERY CO., LTD. (TAIWAN)

Tel : +886-2-2880-5600  
Fax : +886-2-2888-3300  
mail : [csb@csb-battery.com.tw](mailto:csb@csb-battery.com.tw)

#### BEIJING OFFICE. (CHINA)

CSB BATTERY TECHNOLOGIES (BEIJING) CO., LTD.  
Tel : +86-10-5820-5336/5338  
Fax : +86-10-58203053  
mail : [chinasls@csb-battery.com](mailto:chinasls@csb-battery.com)

#### AMERICA HQ

CSB BATTERY TECHNOLOGIES INC. (U.S.A)  
Tel : +1-817-244-7777/1-(800)3-CSB-USA(272872)  
Fax : +1-817-244-4445  
mail : [csb@csb-battery.com](mailto:csb@csb-battery.com)

#### SHANGHAI OFFICE. (CHINA)

CSB BATTERY LOGISTIC (SHANGHAI) CO., LTD.  
Tel : +86-21-5046-1622/5046-0833  
Fax : +86-21-5064-1046  
mail : [chinasls@csb-battery.com](mailto:chinasls@csb-battery.com)

#### EUROPE HQ

CSB Battery Europe BV.  
Tel : +31(0)-180-418-140  
Fax : +31(0)-180-418-327  
mail : [eurossales@csb-battery.eu](mailto:eurossales@csb-battery.eu)

#### SHENZHEN OFFICE. (CHINA)

CSB BATTERY LOGISTIC (SHANGHAI) CO., LTD.  
Tel : +86-755-8831-6488/6396/6356  
Fax : +86-755-8831-6548  
mail : [she@csb-battery.com.cn](mailto:she@csb-battery.com.cn)